

DATA LOG / DATA LOG 2

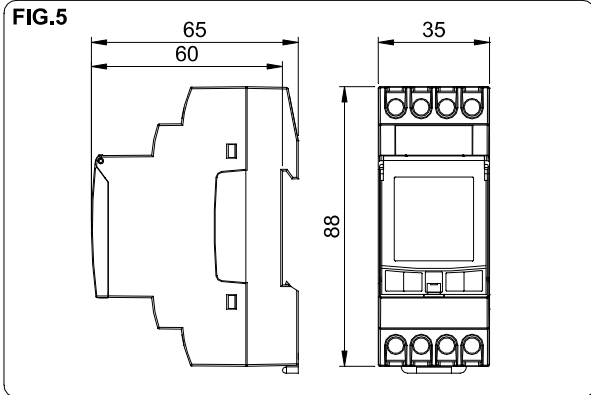
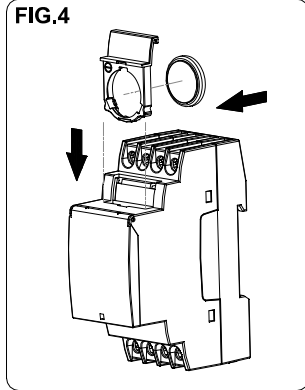
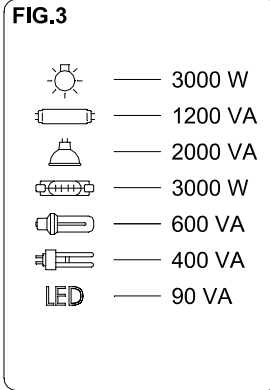
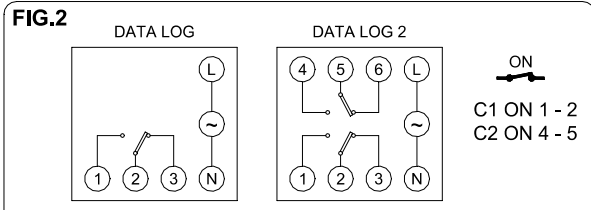
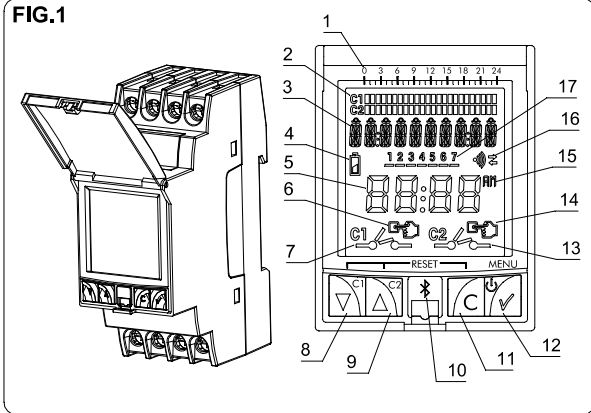

ENG

TIME SWITCH

- FIG.1**
- | | | | |
|-----|-----------------------------|-----|---|
| 1. | Time scale | 2. | Schedules |
| 3. | Text line | 4. | Low-battery symbol |
| 5. | Hour / Date | 6. | C1 manual operation (blinking) / C1 permanent manual (fixed) |
| 7. | C1 relay status symbol | 8. | Scroll down / C1 manual operation |
| 9. | Go up / C2 manual operation | 10. | Bluetooth dongle connector |
| 11. | Cancel option / Go back | 12. | Accept option / Enter the menu / Switch on the device without power |
| 13. | C2 relay status symbol | 14. | C2 manual operation (blinking) / C2 permanent manual (fixed) |
| 15. | 12 H / 24 H | 16. | Transfer symbol |
| 17. | Days of the week | | |

OPERATING INSTRUCTIONS
 DATA LOG / DATA LOG 2 is a digital time switch designed to control any electrical installation. It offers the possibility of performing different types of operations: ON and OFF at a set time, short-term operations or pulses (1 to 59 seconds), and repetitive cycles (1 to 59 seconds or 1 minute to 23 hours and 59 minutes). All of them can be applied to channels C1 and C2 with DATA LOG 2. Furthermore, it includes a series of additional functions such as: automatic DST changes, 4 holiday periods, adjustable screen brightness and programming from Smartphone / Tablet. Menus can be displayed in several languages and they show the schedule for the current day on screen.
 With 1 (DATA LOG) or 2 (DATA LOG 2) independent and voltage-free circuits switched, which allows the programming of up to 40 operations between channel 1 and / or channel 2.

INSTALLATION
 WARNING: Installation and mounting of electrical devices must be carried out by an authorised fitter. **BEFORE PROCEEDING TO THE INSTALLATION, REMOVE POWER SUPPLY.** The device is internally protected against interference by a security circuit. However, some particularly strong electromagnetic fields may alter its functioning. Interference can be avoided if the following installation rules are taken into account:
 - The device must not be installed near inductive loads (engines, transformers, contactors, etc.)
 - It is advisable to devise a separate line for supply (provided with a network filter if necessary).
 - Inductive loads must be provided with interference suppressors (varistor, RC filter).
 If the time switch is used in combination with other devices in an installation, it should be made sure that the constituted unit does not generate extraneous disturbances.
RESTORE SUPPLY ONCE THE DEVICE IS FULLY INSTALLED.

MOUNTING
 Electronic control device of independent mounting in fuse box, with 35 mm. symmetrical profile, according to EN 60715 standard (DIN Rail).

CONNECTION
 Connect power supply according to the diagram in FIG. 2. Phase and Neutral positions must be respected, checking the connections made. A wrong connection may destroy the device.

START-UP
THE DEVICE MUST BE POWERED to be able to execute the installation control. When this happens, the display will light up and the MAIN screen will appear.
 When the device is not powered the display remains off, storing all the date and time programming during the power-reserve period (4 years) thanks to the incorporated lithium battery. If installed without battery, the device has a security power-reserve of approx. 48 hours.
 With the device unpowered, when pressing the MENU key, the display temporarily lights up to allow programming. If after 5 seconds no key is pressed, the display will be turned off again. These devices have four keys for their setting and programming.
 The display shows the following information:
 ▪ Schedule with the day's operations (except on holidays). A schedule for each channel with 24 divisions in which each segment represents 1 hour ON.
 ▪ The display has a text line that will show the following information alternatively:
 Current date → PERMANENT operation → Active HOLIDAY period
 ▪ Complete time.
 ▪ Manual operation symbol. It blinks when a manual switching is activated and if the switching is PERMANENT the symbol is fixed.
 ▪ State of C1 / C2 circuits: ON, OFF

SETTINGS
 DATA LOG / DATA LOG 2 are factory programmed with the current date and time, and configured as follows:

- Time Mode: 24 h
- Standard to DST change: Automatic (last Sunday of March)
- DST to Standard change: Automatic (last Sunday of October)
- Holidays: NO (all 4 periods disabled)
- Programs: None

MANUAL OPERATION
 Activated or disabled, temporarily reversing the state of the circuits manually from the main screen, by pressing the ▼ C1 or ▲ C2 keys.
 The symbol will appear blinking on screen over the handled channel until we press ▼ C1 or ▲ C2 again, returning to the previous state.

PROGRAMMING
 Programming is based on menus and submenus through which we can move to program operations or adjust the device. The main menu can be accessed from the standby screen by pressing ✓. With keys ▼ and ▲ we will move through the different menus and by pressing ✓ we will access them. To go back to the previous menu we press C

The details to be programmed always appear blinking on screen.
 The structure of the menus is the following:

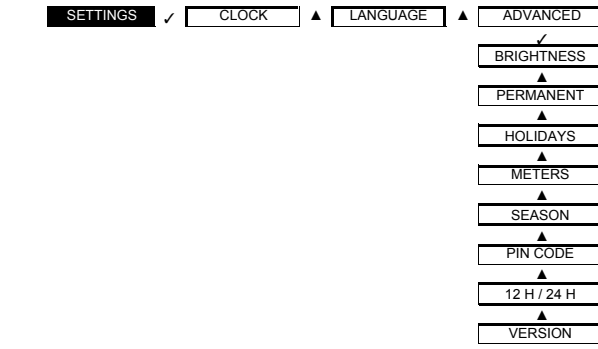
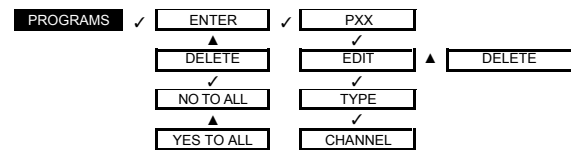

PROGRAMS. This is the menu where the different operations are programmed. There are 40 memory spaces (P-01 to P-40).

▪ **ENTER.** We enter by pressing ✓, and with the ▼ and ▲ keys we move through the different programs stored in the memory.
 When entering this menu, if any programs have already been stored, the first program that was stored appears in the display text line: "P-01", and with the ▲ key we can go up the different stored programs until we reach the first empty program, in which the display text line will show "P-XX EMPTY" alternating with the number of programs available left in the memory of the device.
 When entering this menu, if no other programs have been created, the display text line will show: "P-01 EMPTY" alternating with "40 LEFT" referring to the memory spaces available.
 If we wish to modify or create a program we move to it with the ▼ and ▲ keys, and press ✓. Next, with the ▼ and ▲ keys we select one of the following options:
 ○ **EDIT.** This option allows us to choose the type of operation that will be performed in the selected program. By pressing ✓, "ON TYPE" will be displayed and with the ▼ and ▲ keys we can choose the type of operation. The operations can be:
 ON TYPE. Switch-on of the connected circuit at a fixed time.
 OFF TYPE. Switch-off of the connected circuit at a fixed time.
 ○ **CYCLE TYPE.** ON and OFF operations performed repeatedly from beginning to end. To program the beginning of the cycle we have to indicate the hour, minutes, and days of the week when this cycle will begin. Next, we need to specify the respective ON and OFF duration (in hours, minutes or in seconds). To finish, we must indicate the hour, minutes, and days of the week when this cycle will stop operating.
 ○ **PULSE TYPE.** Switch-on of the circuit in a pulse of a set duration at a fixed time of the day. Once the type of operation has been chosen, we have to select the channel or channels it affects (C1, C2 or C1 + C2).
 Next, we enter the operation starting hours and the rest of the necessary times according to the selected operation.

HOLIDAY PERIODS program
 If when validating the last day of the week with the ✓ key we keep it pressed, we select this operation as holiday. The word HOLIDAY is displayed and with the ▼ and ▲ keys we select one of the 4 holiday periods.

○ **DELETE.** By pressing ✓, the selected program is deleted. Since all programs are stored consecutively, deleting one program can change the number assigned to each one of them.

▪ **DELETE.** This option allows for deleting all the operations of the last 40 programs in just one step.

We choose to perform the switch-on program at 10 pm

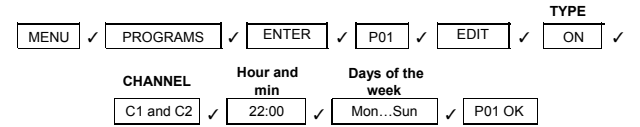

We choose to perform the switch-off program at 12 am

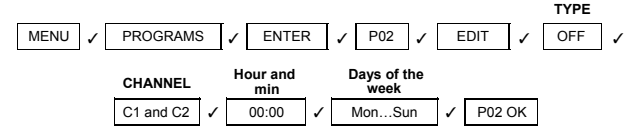

We choose to perform the cycle program, with a 5-second ON and a 10-second OFF period, which will start at 6:00 and will finish at 8:00 during the entire week

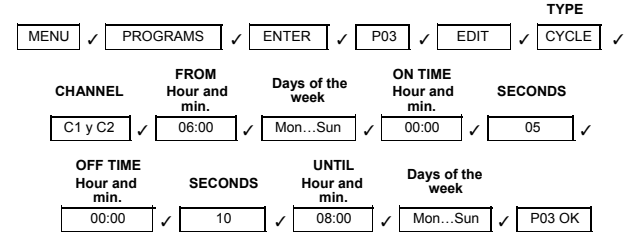

We choose to perform the pulse program, which will perform a 5-second ON period starting at 11:30 during the entire week

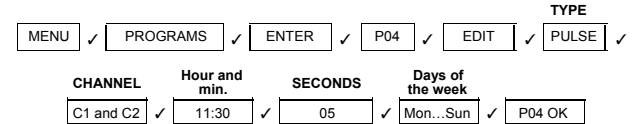

SETTINGS. This is the menu where we configure the device.
 ▪ **CLOCK.** Sets the time of the device. The variables to configure are (in this order): Year, month, day, hour and minute. The day of the week is calculated automatically.
 ▪ **LANGUAGE.** This is the menu where the language of the device is selected.
 ▪ **ADVANCED.** This is the menu where most of the device configuration can be done.

- **BRIGHTNESS.** Menu where we can select the brightness of the display. MINIMUM, LOW, MEDIUM, HIGH, or MAXIMUM. The brightness on screen will be adjusted if we validate the visualised level.
- **PERMANENT.** The menu where we can set a permanent operation (ON or OFF) of channel C1 and channel C2. With the ▼ and ▲ keys we move through the different options: C1: YES → C1: NO → C2: YES → C2: NO. We validate with 3 our desired option. The device will not take notice of the operation programming for the selected channel if we choose the YES OPTION.
- **HOLIDAYS.** It has 4 PERIODS that can be programmed to perform the operations selected in the programming of HOLIDAY PERIODS. If no operation is programmed in a period, the channels will remain OFF during said period. PERIOD 1 ...4
 EDIT. The month, day, hour and minute of the beginning of the period and the month, day, hour and minute of the end of the period are programmed. This period will be repeated year after year.
 DELETE. The selected period is deleted.
- **METERS.** Menu where the switch-on time of each circuit is indicated (in hours). Accessing the meter of each channel with ✓, they can be set to zero. Select DELETE YES and validate.
- **SEASON.** Allows for adjusting the time change from daylight saving to standard time and vice versa.
 ACTIVE. Automatically makes the time change from daylight saving to standard time or vice versa, in accordance with each country's legislation. (EU the last Sunday of March and the last Sunday of October)
 INACTIVE. Does not make the time change.
- **PIN CODE.** Menu to activate or disable the keyboard lock to prevent unwanted access to the device settings.
 - INACTIVE. Keyboard lock disabled.
 ACTIVE. Keyboard lock activated. And we are required to program a four-figure PIN CODE. This protection will be activated 30 seconds after we come out of the settings and return to the display in standby mode. From that moment on when any key is pressed the message "PIN CODE" will appear on screen. To unblock the access to the device, we will need to enter the PIN CODE programmed in its activation. The device will be unblocked for 10 seconds. During this time we will be able to access the settings menu by pressing 3. After 30 seconds without handling the device, it will get locked again.
- **12H - 24H.** With the ▼ and ▲ keys we select the mode in which we wish to see the time. We validate the selection with ✓
- **VERSION.** Menu where the software version of the device is shown.

If simultaneous operations are programmed we have to take into account that some have priority over the others. The priority order is as follows:
 PERMANENT MODE → MANUAL → PROG_01 → PROG_02 → ... → PROG_40

RESET. SET TO ZERO.
 Starting on standby mode (main screen), press the C key and while keeping it pressed press the ▼ and ▲ keys simultaneously for more than 3 seconds. The display gets turned off, all programming is deleted. The device must be powered.
 We can also perform a quick deletion that does not affect the programming by pressing the four keys simultaneously. The device must be powered.

BATTERY CHANGE. FIG.4
 The device has a power-reserve of 4 years, by means of a replaceable CR2032 lithium battery. Battery replacement is made by removing the battery holder placed on the front of the device through a flat-head screwdriver. Observe the battery polarity as marked on the battery holder.
 When the battery is dead and the device is powered the battery symbol appears on screen.
NOTE: When changing the battery the device's programming is not lost, and neither is the current time.
TURN OFF THE POWER SUPPLY TO REPLACE THE BATTERY

PROGRAMMING VIA SMARTPHONE/TABLET
 The Bluetooth dongle is required for the communication with the device. Remove the front cover and insert the dongle.
 This type of programming requires an Android (Bluetooth 4.0) or iPhone (4S or superior) device and the download of the "ORBIS DATA LOG" app from the corresponding Market. Once installed, follow the App's instructions.

TECHNICAL FEATURES

Rated voltage and frequency	As indicated in the device
Resistance	± 10%
Breaking capacity:	DATA LOG: μ 16 (10) A / 250 V~ DATA LOG 2: μ 2x16 (10) A / 250 V~
Maximum recommended loads (N.A.):	FIG.3 16 VA (1.3 W) maximum AgSnO ₂ switched.
Own consumption	Back-lit LCD
Contact	± 1 s / day at 23 °C
Display screen	Accuracy variation with temperature
Running accuracy	± 0.15 s / °C / 24 h
Accuracy variation with temperature	48 h (no battery and no network connection)
Power reserve	1S, 1T, 1U Class A 40
Type of action	1 channel DATA LOG; 2 channels DATA LOG 2
Software class and structure	ON/OFF, PULSE (1 to 59 sec.) and CYCLES (1 to 59 sec. or 1 min to 23h and 59 min).
Memory spaces	± 1 second
No. of channels	-10 °C at +45 °C
Types of operations	-20 °C at +60 °C
Astronomical adjustments	2
Operating temperature	IP 20 according to EN60529
Transport and storage temperature	II under correct mounting conditions
Pollution situation	2.5 kV
Protection level	+ 80 °C for 21.2.5
Protection class	Sealable
Transient impulse voltage	With screw terminal for wire cross section of up to 4mm ²
Temperature for the ball test	CR2032 - 3 V - 220 mAh
Keyboard access cover	2 DIN modules (35 mm) FIG.5
Connection	
Battery	
Wrapping size	

WARNING:
 This time switch includes a battery whose contents may be damaging to the environment. Do not get rid of the product without taking the precaution of dismantling the battery and placing it in an appropriate recycling container, or sending the product back to the factory.

Subject to technical changes – for further information: www.orbis.es